

Pressure Switch (YLKG)



YLKG



- Service Environment: Indoor or Outdoor Use, all parts have corrosion resistant finishes
- Temperature Range: 0°C - 80°C
- Cover Tamper: Tamper Resistant Screws
Optional Cover Tamper Switch Available
- Connection: 1/2-14NPT Thread
- Electrical Ratings: 125/250VAC 15A

Different pressure springs are selected according to the difference between the power range of the Pressure Switch (0-20 psi, 0-60 psi, 0-120 psi).

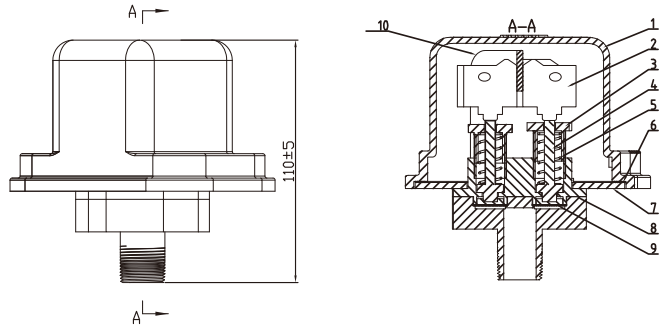

MATERIAL SPECIFICATION

Part No.	Part	Standard Specification	Options
1	Outer Shell	ADC12	
2	Micro Switch		
3	Regulating Accessories	PA66+GF30	
4	Stem	PA66+GF30	
5	Compression Spring	65#	
6	Sealing Washer	PA66+GF30	
7	Back Shell	ADC12	
8	Pressure parts	PA66+GF30	
9	Pressure Diaphragm	EPDM	
10	Micro Stents	Carbon Steel Q235	AISI 304

Note: For special material request other than standard specification, please indicate clearly on the inquiry or order list.

TYPICAL ELECTRICAL CONNECTIONS

